

The Floater CoaterTM



Why use the LSP FloaterCoater?

Rollers Float with the Movement of the Stock

- ◆ Stainless steel inner chassis, housing the rollers, can float from 1.500 inches to 2.500 inches, depending on the unit.
- ◆ Unique design allows the setup person a degree of clearance should the stock not be lined up exactly with the die.
- ◆ Rollers follow the movement of the stock.

Stainless Steel Construction

- ◆ Sturdy construction.
- ◆ Resists rust.
- ◆ Maintains new look years after heavy use.

Electronically Controlled

- ◆ Electronically controls amount and timing of lubricant delivered to the rolls.

Selective Lubrication

FloaterCoater can be Configured to:

- ◆ Dispense equal quantities of lubricant to top and bottom roll.
- ◆ Dispense different quantities of lubricant to top and bottom rolls.
- ◆ Can be reconfigured in the field should different lubrication be required.

Good for both Heavy and Light lubricants

- ◆ Handles heavy honey oils down to synthetics and vanishing oils.

Fast Roller Removal

- ◆ Remove lubricant rolls in less than two minutes.

Fast Start-up After Setting Overnight or a Weekend

- ◆ Manual button allows lubricant to re-coat the rollers surface in less than a minute.

Fast Lubricant Changeover

- ◆ Multiple Reservoirs with quick-change fittings store different lubricants for fast changeover when necessary.
- ◆ Most changeovers require no cleaning. If cleaning is required, it can be accomplished in less than 10 minutes.

Reduce Cost with Controlled Lubrication

- ◆ Using less lubricant - reduces lubricant cost.
- ◆ Using less lubricant - reduces part cleanup cost.
- ◆ Using less lubricant - reduces plant maintenance cost.

Improved Employee Moral

- ◆ Parts, floors and the work area stay cleaner, reducing environmental problems and creating a cleaner, more productive working atmosphere.

Lower Lubricant Consumption & Increase Die Life



The Basic FloaterCoater Line

Units with Attached Manual On/Off Valves

Manual On/Off Valves are attached on each side of the cabinet, one set for the top roll and one set for the bottom roll. Each On/Off Valve regulates supply of lubricant to a Dispensing Head. The Dispensing Head disperses the lubricant onto a specific area of the roll.

Attached manifolds simplify installation - Simply mount, attach the lubricant supply and return lines and your done!

The FloaterCoater line is comprised of eight standard units to cover the common applications found in stamping. The units are divided into three families. Each family has the same size housing with the exception of the length, and they use the same diameter rolls.

2.5" rolls

- FC1112A, 12 inch stock
Three Dispensing Heads per Roll
- FC1118A, 18 inch stock
Five Dispensing Heads per Roll
- FC1124A, 24 inch stock
Five Dispensing Heads per Roll

Reference pages 7 & 8 for other available systems.



3" rolls

- FC1130A, 30 inch stock
Five Dispensing Heads per Roll
- FC1136A, 36 inch stock
Seven Dispensing Heads per Roll
- FC1148A, 48 inch stock
Seven Dispensing Heads per Roll

Reference pages 7 & 8 for other available systems.



4" rolls

- FC1160A, 60 inch stock
Seven Dispensing Heads per Roll
- FC1172A, 72 inch stock
Seven Dispensing Heads per Roll

Reference pages 7 & 8 for other available systems.



Additional accessories are required to complete a system. See Page 6 to select Roll Type. See Page 9 to select Electronic Control Package. See back page to select Reservoir/Pump Module.

The FloaterCoater is designed to dispense all types of lubricants, from honey oil to water-soluble oils, for a precise, controlled coating on coil stock.

An air cylinder on each side of the FloaterCoater opens the rolls to feed the coil stock. Once the stock is loaded, the FloaterCoater is closed with springs, and the coil is held firmly between the rollers.

The lubricant - from a remote reservoir - is moved to the FloaterCoater by a diaphragm pump. An Electronic Controller opens and closes a solenoid valve, allowing lubricant to feed the unit in precise synchronization with the press.

External Frame, Heavy Duty, Stainless Steel

Low profile with a small footprint allows installation in confined areas. Full enclosure built to protect the lubricant delivery system. Ruggedly built to withstand normal buckling of stock.

Bearings

Rollers rest against stainless steel bearings, allowing them to turn freely.

Lubricating Rolls

Disperses lubricant over the coil stock in an even, precise coating. Available in different textures of polyurethane or felt. Free rolling and designed for removal in less than one minute. Refer to page 6 for full roller specifications.

Snap-Lock Retainer

Spring-loaded locking mechanism allows the upper roll to snap into a fixed, locked position.

Overflow Basin

Excess lubricant is collected in the lower channel of the Outer Frame and drains back into the main reservoir.

Floating Internal Housing, Stainless Steel

An Inner Frame houses and protects the Lubricating Rolls and other functional parts of the FloaterCoater. Self centering pistons on each side allows the frame to float with the normal motion of the stock. See page 11 for specifications as to the amount of float for different sized units.

Spring Closing System

Four Springs close the two Lubricating Rolls when pressure is released from self-centering pistons.

Leveling Springs

Aid in the floating mechanism of the Internal Housing.

Self-Centering Cylinders

Pneumatic cylinders open the rollers to allow for quick coil change and automatically adjust to the passline of the stock.

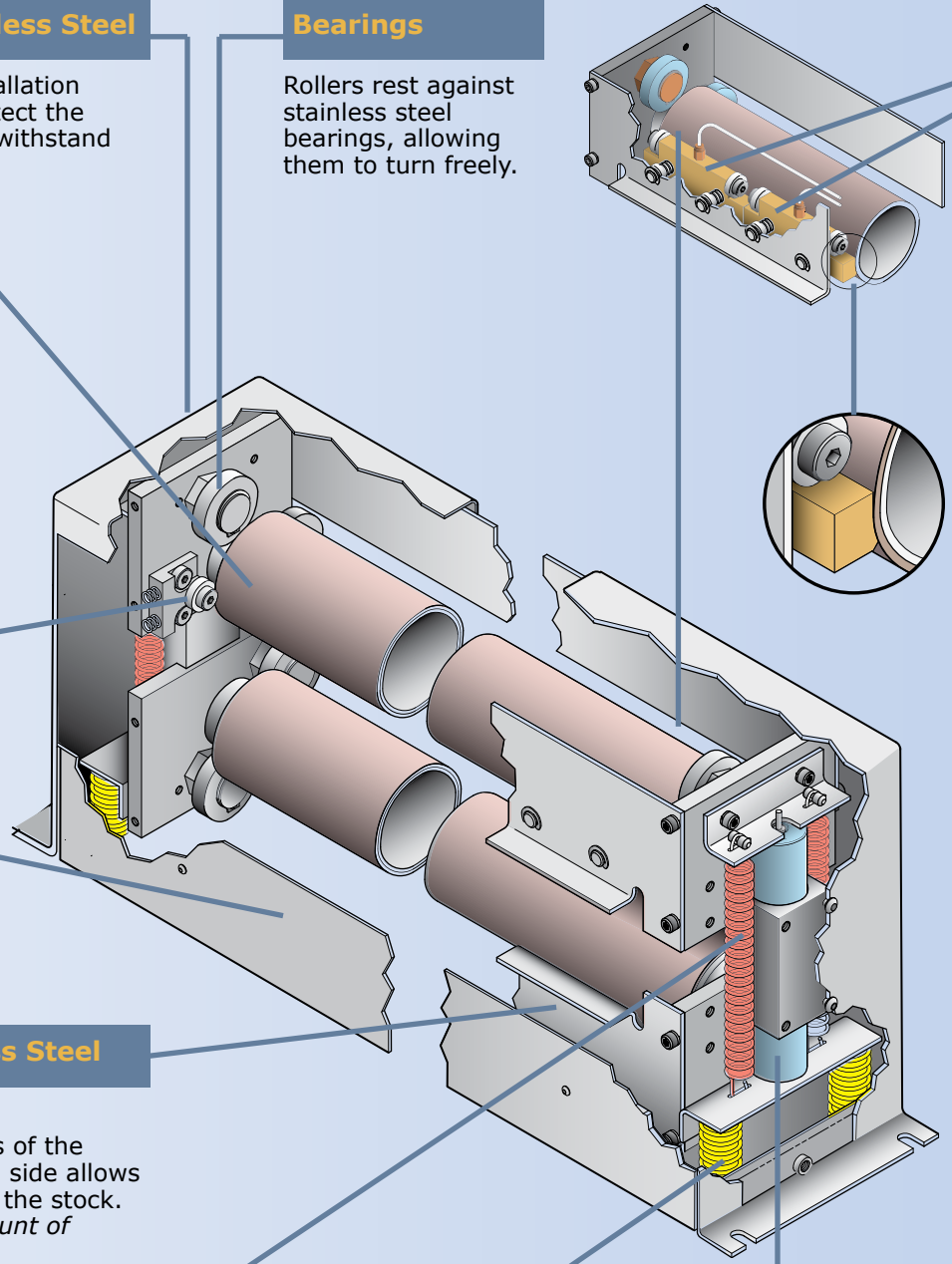

Here's how it works!

Dispensing Heads (Hidden)

Heads are individually selected by the On/Off Valve and are spring loaded against the lubricating rolls. Faces conform to the lubricating roller's curvature, ensuring an even spread of lubricant onto the roll.

On/Off Valves

Shut off valve for each Dispensing Head to allow for selective lubricating. Valve shuts off dispensing heads that are not needed.

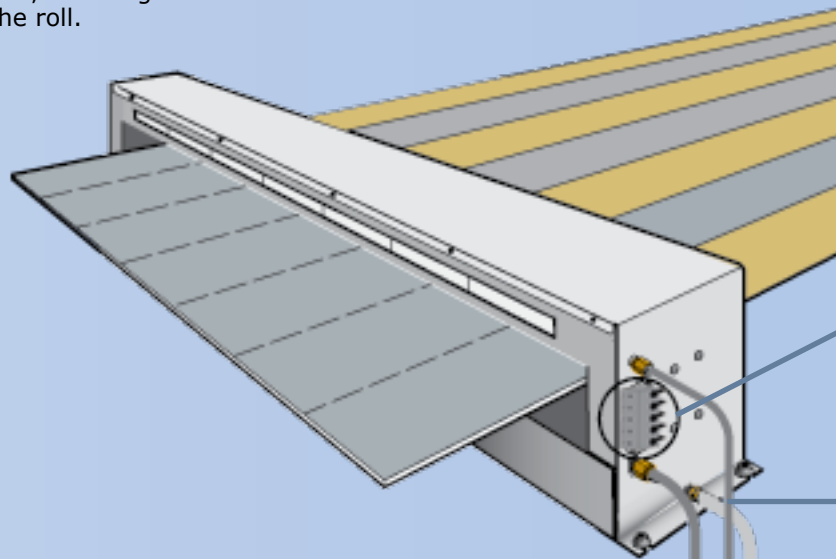

Air Inlet

Lubricant Inlet

Lubricant Return

Electronic Controller

The Electronic Controller is programmed to set the amount and timing of lubricant dispensed to the rolls. It controls the Solenoid Valve that is attached to the Diaphragm Pump. Opening the valve allows lubricant to flow to the FloaterCoater Manifolds, closing the valve stops the flow of lubricant. This cycle is repeated each cycle of the press.

Solenoid Valve, 24V

Signal received from the Electronic Controller opens the Solenoid Valve to allow lubricant to flow into the FloaterCoater. When the cycle ends, the Solenoid closes, stopping the flow of lubricant.

Reservoirs and Diaphragm Pump

Available in 4, 8 or 15 gallon capacities, includes Diaphragm Pump. When Solenoid Valve is opened, the pump becomes active and transfers lubricant from the Reservoir to the FloaterCoater. The Reservoir is free standing or can be attached to the press. Level Control Optional.

Three different types of rolls are offered to cover a wide range of applications. Each roll is designed to deposit different film thicknesses of lubricant to the metal being coated.

Since it takes only minutes to change the rolls, different rolls with different finishes can be kept and switched when the film thicknesses requirement changes from one job to another.

Polyurethane with a Smooth Surface Finish

Applies a very light coating to the stock. Because the rolls are smooth they deposit the lubricant and then squeeze out most of the lubricant which leaves a faintly visible coating. Requires only a small volume of lubricant. Increasing volume will not alter light film applied to the stock.

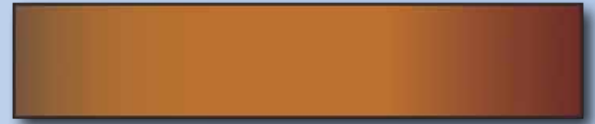

Light Film

Smooth finish provides a light coating.

Felt Rolls

The felt rolls (our most popular style) are absorbent giving more versatility in the lubricant thickness being applied to the stock. A small amount of lubricant provides a light coating. Increasing the amount of lubricant will provide a medium or heavier coating. Although roller life may not be as long as the polyurethane, felt rolls can be quickly replaced in the field and cost less.

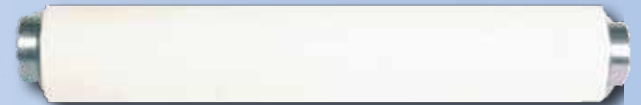
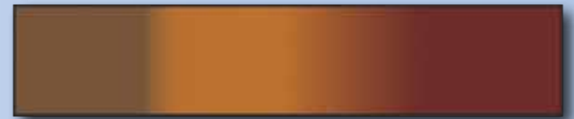

Medium Film

Absorbant Hatch provides a medium coating.

Polyurethane with a Textured Finish

This textured finish provides a heavier coating to the stock. When lubricant is deposited on the roll, it is held in pockets and crevices before being transferred to the stock, leaving a heavier coating than the smooth polyurethane rolls. Decreasing the volume will lighten the film thickness.



Heavy Film

Textured finish provides a heavy coating.

Applying the Lubricant Coating

Applying the Lubricant Only Where Needed

The FloaterCoater offers the ability to lubricate specific areas of the coil stock when needed. Not only does this save on lubricant consumption, it also saves on cleaning and disposal cost. Each Dispensing Head is controlled with an ON/OFF Valve. Closing a valve prevents lubricant from coating a specific area of the coil stock.

Examples of lubricant distribution by controlling where lubricant is dispensed.

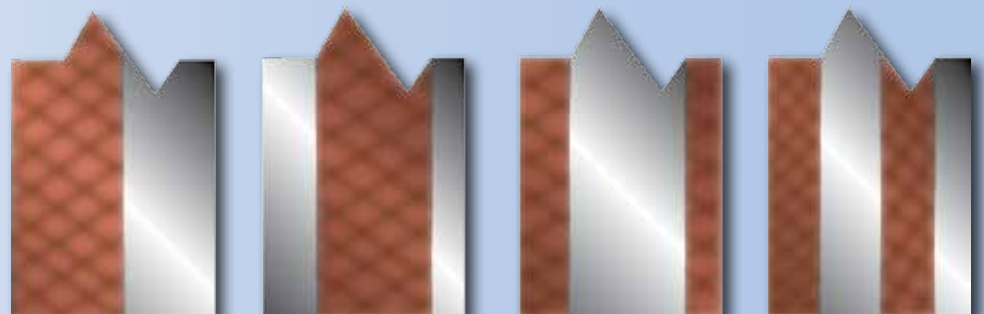

Basic FloaterCoater Lubricant Distribution Method

The FloaterCoaters On/Off valves that allow lubricant to flow to the dispensing heads are located in the cabinet. The valves for the upper roll are located on the right side of the FloaterCoater and the valves for the bottom roll are located on the left side of the cabinet. The fluid inlet will accept either one or two fluid lines depending on whether lubricant is to supply lubricant in equal amounts to the top and bottom roll or if lubricant is to be supplied to the top and bottom rolls in different quantities.

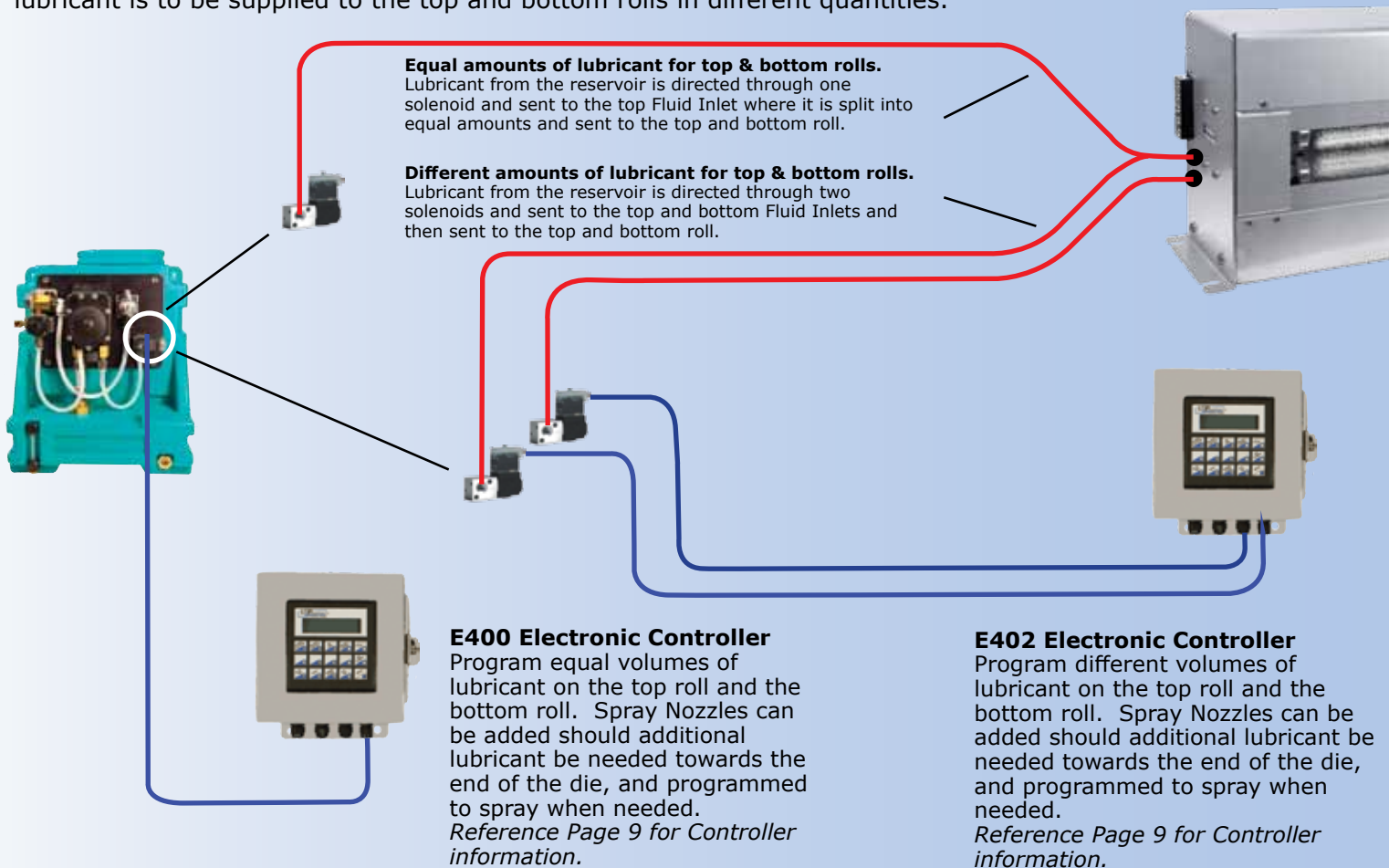

The Basic FloaterCoater with On/Off Valves Cabinet Installed

The *Basic* FloaterCoater when Dispensing Equal Amounts of Lubricant to the Top and Bottom Rolls.

Includes: FloaterCoater and On/Off Valves in the Cabinet.

*Reservoir with Diaphragm Pump, Rolls and the E-400 **Ordered Separately.***

Reference back cover for Reservoir specifications.

The *Basic* FloaterCoater when Dispensing Different Amounts of Lubricant to the Top and Bottom Rolls.

Includes: FloaterCoater and On/Off Valves in the Cabinet.

*Reservoir with Diaphragm Pump, Rolls and the E-402 **Ordered Separately.***

Reference back cover for Reservoir specifications.

Model	Size	Manifold in Cabinet
FC1112A	12 inch FloaterCoater	6 On/Off Valves
FC1118A	18 inch FloaterCoater	10 On/Off Valves
FC1124A	24 inch FloaterCoater	10 On/Off Valves
FC1130A	30 inch FloaterCoater	10 On/Off Valves
FC1136A	36 inch FloaterCoater	14 On/Off Valves
FC1148A	48 inch FloaterCoater	14 On/Off Valves
FC1160A	60 inch FloaterCoater	14 On/Off Valves
FC1172A	72 inch FloaterCoater	14 On/Off Valves

Model	Size	Remote Manifold with
FC1112AA	12 inch FloaterCoater	6 On/Off Valves
FC1118AA	18 inch FloaterCoater	10 On/Off Valves
FC1124AA	24 inch FloaterCoater	10 On/Off Valves
FC1130AA	30 inch FloaterCoater	10 On/Off Valves
FC1136AA	36 inch FloaterCoater	10 On/Off Valves
FC1148AA	48 inch FloaterCoater	14 On/Off Valves
FC1160AA	60 inch FloaterCoater	14 On/Off Valves
FC1172AA	72 inch FloaterCoater	14 On/Off Valves

Configuring the Deluxe Floater Coater for Remote Control

The FloaterCoaters On/Off valves that allow lubricant to flow to the dispensing heads are removed from the cabinet and placed up to 10 feet away from the FloaterCoater. This allows the user to open or close lubricant to the dispensing heads from a remote location without having to walk around the coil feeder to adjust the valves. Two systems are available, one for dispensing equal amounts of lubricant to the top and bottom rolls or one to dispense different programmed amounts of lubricant to the top and bottom rolls.

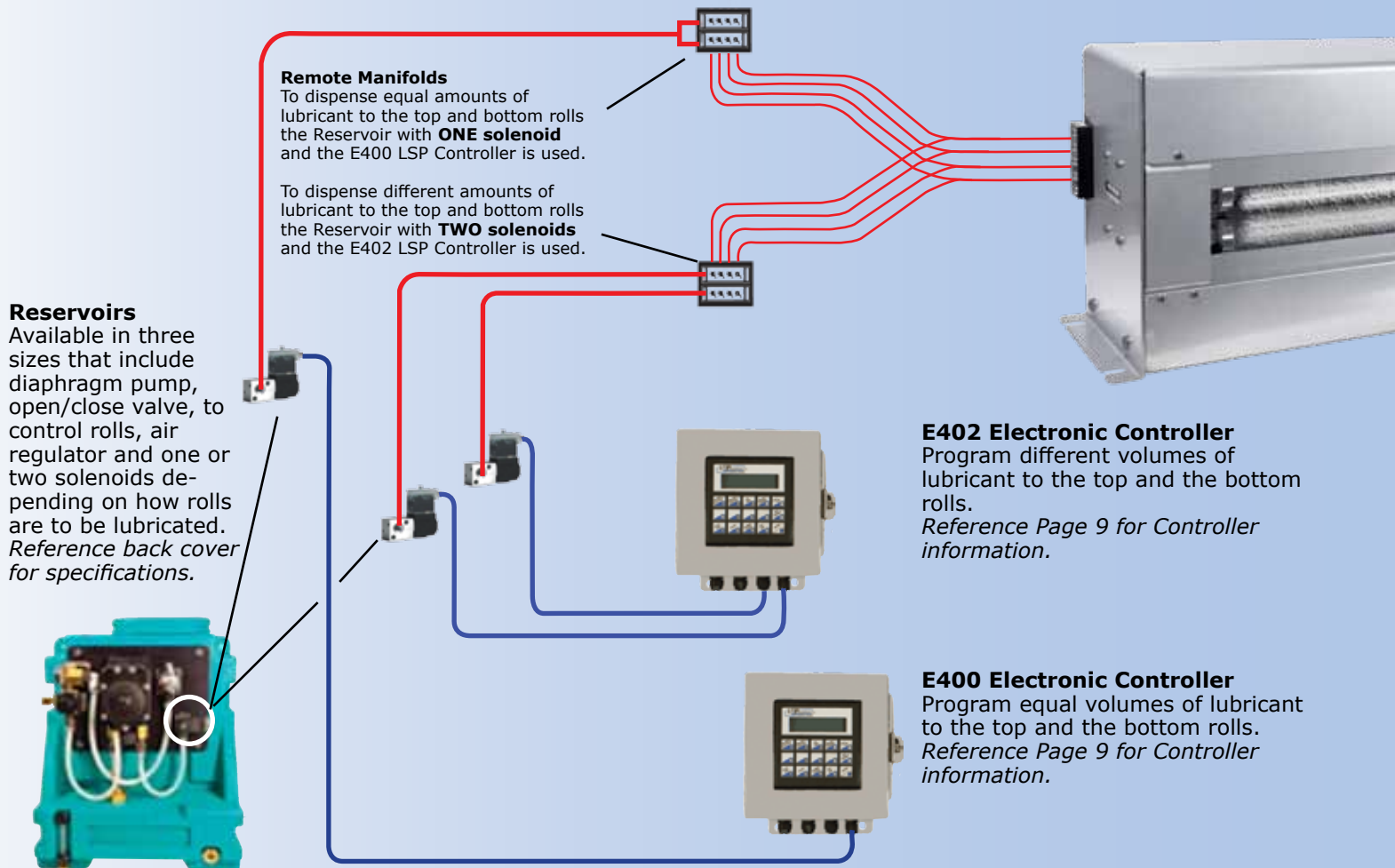

The Deluxe FloaterCoater with Remote On/Off Valves

The *Deluxe* FloaterCoater when Dispensing Equal Amounts of Lubricant to the Top and Bottom Rolls.

Includes: FloaterCoater, Remote On/Off Valves and 10 feet of tubing

Reservoir with Diaphragm Pump, Rolls and the E-400 **Ordered Separately.**

Reference back cover for Reservoir specifications.

Model	Size	Remote Manifold with
FC1212A	12 inch FloaterCoater	6 On/Off Valves
FC1218A	18 inch FloaterCoater	10 On/Off Valves
FC1224A	24 inch FloaterCoater	10 On/Off Valves
FC1230A	30 inch FloaterCoater	10 On/Off Valves
FC1236A	36 inch FloaterCoater	10 On/Off Valves
FC1248A	48 inch FloaterCoater	14 On/Off Valves
FC1260A	60 inch FloaterCoater	14 On/Off Valves
FC1272A	72 inch FloaterCoater	14 On/Off Valves

The *Deluxe* FloaterCoater when Dispensing Different Amounts of Lubricant to the Top and Bottom Rolls.

Includes: FloaterCoater, Remote On/Off Valves and 10 feet of tubing.

Reservoir with Diaphragm Pump, Rolls and the E-402 **Ordered Separately.**

Reference back cover for Reservoir specifications.

Model	Size	Remote Manifold with
FC1212AA	12 inch FloaterCoater	6 On/Off Valves
FC1218AA	18 inch FloaterCoater	10 On/Off Valves
FC1224AA	24 inch FloaterCoater	10 On/Off Valves
FC1230AA	30 inch FloaterCoater	10 On/Off Valves
FC1236AA	36 inch FloaterCoater	14 On/Off Valves
FC1248AA	48 inch FloaterCoater	14 On/Off Valves
FC1260AA	60 inch FloaterCoater	14 On/Off Valves
FC1272AA	72 inch FloaterCoater	14 On/Off Valves

LSP Electronic Controllers

The LSP Electronic Controllers Give Unlimited Controllability in Lubricating Options.

1. Time Delay

Determines how long a delay will transpire before the Controller will send an ON signal to the Solenoid Valve.

2. Counter

After receiving a signal it sets the Solenoid to actuate on any cycle of the press from one to ninety nine.

3. Pulsator

Signals to for the Solenoid to pulsate one to a multitude of actuations per cycle of the press.



FC400 Includes:
Proximity Sensor and one outlet
Cable to attach to a Solenoid Valve

FC400 Features

- ◆ Use when equal quantities of lubricant are used on the top and bottom rolls.
- ◆ Designed to control a single solenoid valve that dispenses equal amounts of lubricant to the top and bottom rolls.
- ◆ The On/Off valves supplied with the FloaterCoater allow individual Dispensing Heads to be turned off if not needed.

NOTE: Fluid Solenoid Valve is not included with the FloaterCoater. It is included with the *FC7300 Series Reservoirs* on the back page or can be ordered separately as an *E421 Solenoid Valve* if other types of reservoirs are used.

FC402 Features

- ◆ Use when equal volumes of lubricant are used on the top and bottom rolls.
- ◆ Designed to control two solenoid valves, one controlling the amount of lubricant to the top roll and one controlling the amount of lubricant to the bottom roll.
- ◆ The On/Off valves supplied with the FloaterCoater allow individual Dispensing Heads to be turned off if not needed.

NOTE: Fluid Solenoid Valve is not included with the FloaterCoater. It is included with the *FC7300 Series Reservoirs* on the back page or can be ordered separately as an *E421 Solenoid Valve* if other types of reservoirs are used.



FC402 Includes:
Proximity Sensor and two outlets
Cables to attach to two Solenoid Valves



Other Controllers

If extra outlets are needed to accommodate spray nozzles in the die area the MaxaMizer Controller can be used. It is capable of handling four to twelve outlets. Each outlet can be individually programmed. Two outlets can handle the top and bottom roll and other outlets are available for nozzles when needed.

Nozzle Assemblies

In some applications on long dies or where there are trouble areas in the die, it may be necessary to apply lubricant in addition to that from FloaterCoater rolls. A LSP spray nozzle assembly can be used to add lubricant to that area without investing in another complete system. The nozzle can be used with water soluble, vanishing oil or light viscosity lubricant. An LSP Controller can control lubricant to the FloaterCoater as well as strategically placed nozzles. Should more than one nozzle be necessary, our larger controllers can handle larger number of nozzles. The same diaphragm pump supplying lubricant to the FloaterCoater supplies lubricant to the nozzles.



P926 Nozzle Extender
An eleven inch Nozzle Extender that fits on the P925 Bracket for maneuverability



P925 Swivel Bracket
Fits on a MagnaBase or can be permanently mounted. Move nozzles up, down and rotate 360 degrees.

P905 MagnaBase
Powerful Magnetic Base, accepts the P925 Nozzle Swivel Bracket. The MagnaBase offers easy placement, positioning and removal of the spray nozzle.

P943 Tubing
The ONLY non-metal tubing to be used to supply lubricant to the nozzles. Flexible enough to afford the user easy positioning yet rigid enough to maintain a consistent pattern.

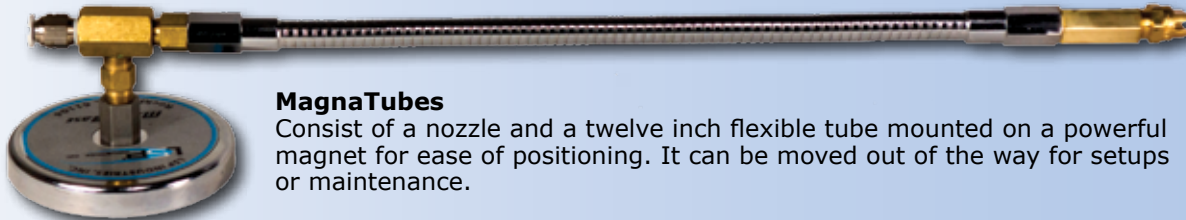

MagnaTubes
Consist of a nozzle and a twelve inch flexible tube mounted on a powerful magnet for ease of positioning. It can be moved out of the way for setups or maintenance.

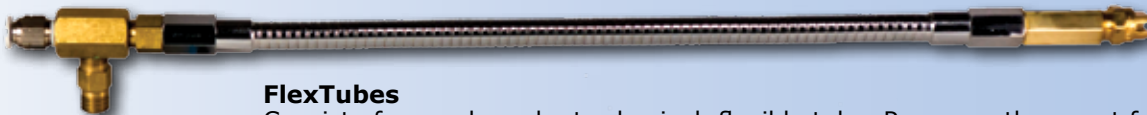

FlexTubes
Consist of a nozzle and a twelve inch flexible tube. Permanently mount for the long running jobs. Easily reposition the direction of the nozzle.

Basic Nozzle
Can be permanently positioned or inserted into the P-925 Swivel Bracket.



In Die Nozzle Tip
Build In Die Nozzle into the die for perfect alignment of the spray pattern



Type of Spray Pattern Given by the Nozzle						
Type of Nozzles	95° Fan	110° Fan	80° Fan	65° Fan	25° Fan	55° Drop
Basic Nozzles	MX1200	MX1201	MX1202	MX1203	MX1205	MX1207
FlexTube	MX1210	MX1211	MX1212	MX1213	MX1215	MX1217
MagnaTube	MX1220	MX1221	MX1222	MX1223	MX1225	MX1227
In Die Nozzle Tip	MX1240	MX1241	MX1242	MX1243	MX1245	MX1247

FloaterCoater Dimensions

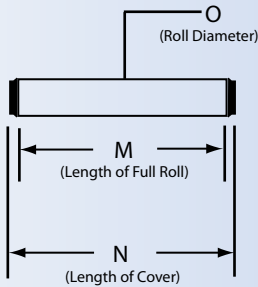
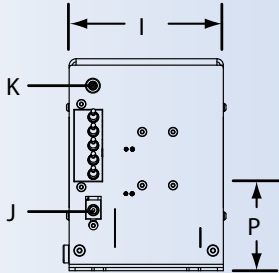
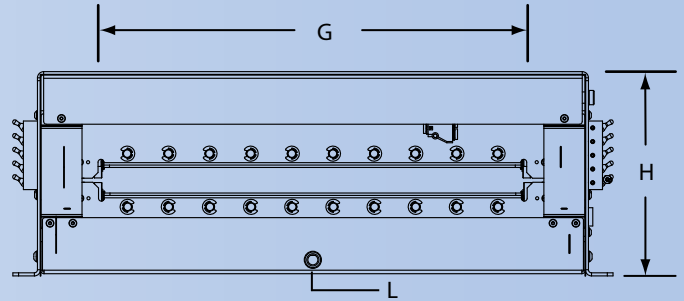
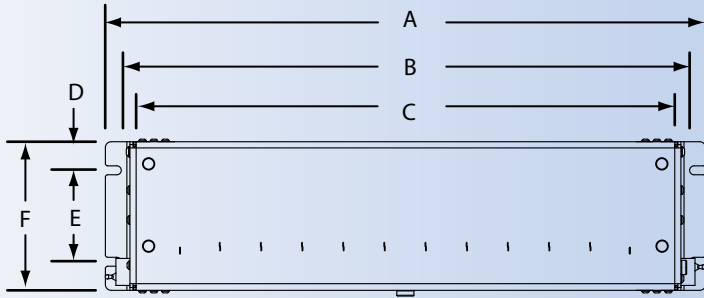

	12" FC	18" FC	24" FC	30" FC	36" FC	48" FC	60" FC	72" FC
A	20.250	26.250	32.250	40.500	46.500	58.500	72.000	84.000
B	19.250	25.250	31.250	39.500	45.500	57.500	71.000	83.000
C	18.100	24.100	30.100	38.200	44.200	56.200	69.600	81.600
D	1.250	1.250	1.250	1.000	1.000	1.000	1.900	1.900
E	4.000	4.000	4.000	6.000	6.000	6.000	6.000	6.000
F	6.500	6.500	6.500	8.000	8.000	8.000	9.800	9.800
G	12.375	18.375	24.375	30.500	36.500	48.500	61.000	73.000
H	8.935	8.935	8.935	11.666	11.666	11.666	15.666	15.666
I	6.500	6.500	6.500	8.000	8.000	8.000	9.800	9.800
J	1/4NPTF	1/4NPTF	1/4NPTF	1/4NPTF	1/4NPTF	1/4NPTF	1/4NPTF	1/4NPTF
K	1/8NPTF	1/8NPTF	1/8NPTF	1/8NPTF	1/8NPTF	1/8NPTF	1/8NPTF	1/8NPTF
L	1/4NPTF	1/4NPTF	1/4NPTF	1/4NPTF	1/4NPTF	1/4NPTF	1/4NPTF	1/4NPTF
M	12.000	18.000	24.000	30.000	36.000	48.000	60.000	72.000
N	13.200	19.200	25.200	31.700	37.700	49.700	62.174	74.174
O	2.250	2.250	2.250	3.000	3.000	3.000	4.000	4.000
P*	4.750	4.750	4.750	5.375	5.375	5.375	7.375	7.375
Q*	1.500	1.500	1.500	2.500	2.500	2.500	2.500	2.500
R*	1.500	1.500	1.500	2.500	2.500	2.500	2.500	2.500

- P Center Line
- Q Not Shown - Distant rolls can open to thread a new coil
- R Not Shown - Maximum float minus 1/2 the thickness of the stock

Reservoir Dimensions

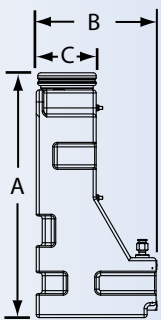

4 Gal. Reservoir

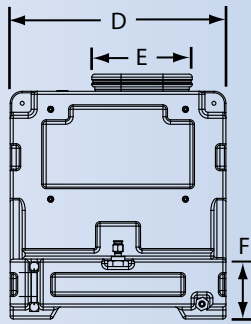

8 Gal. Reservoir

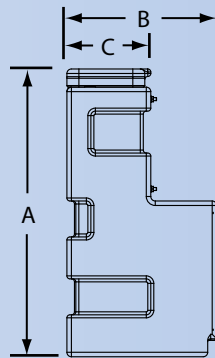

15 Gal. Reservoir

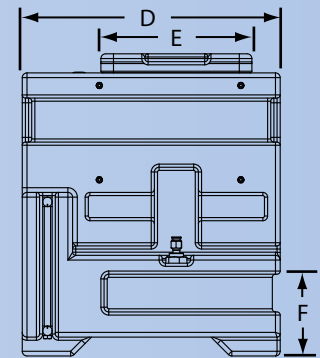

	A	B	C	D	E	F
4 Gal. Res	18.125	9.500	4.500	12.500	7.125	4.500
8 Gal. Res.	21.063	10.000	5.000	18.000	8.375	5.000
15 Gal. Res.	24.625	12.500	7.000	20.500	12.000	8.000

Reservoir dimensions represent base system of Reservoir Modules found on Back Page.

Accessories

Reservoir / Pump Modules

Modules are pre-assembled supply systems, including any of the following: Diaphragm Pump, Reservoir, Lubricant On/Off Valve, or Roller Open/Close Valve.



FC7310 Diaphragm Pump
Used to move fluid to the Floater-Coater

Model	FC7310 Diaphragm Pump	FC2125 Roller Valve Open/Close	E421 Solenoid Valve	Reservoir
STANDARD				
FC7305	Yes	Yes	Yes - One	None
FC7314-C	Yes	Yes	Yes - One	4 Gal.
FC7318-C	Yes	Yes	Yes - One	8 Gal.
FC7320-C	Yes	Yes	Yes - One	15 Gal.
DELUXE				
FC7305-2	Yes	Yes	Yes - Two	None
FC7314-2C	Yes	Yes	Yes - Two	4 Gal.
FC7318-2C	Yes	Yes	Yes - Two	8 Gal.
FC7320-2C	Yes	Yes	Yes - Two	15 Gal.
MAXAMIZER				
FC7405	Yes	Yes	No	None
FC7414-C	Yes	Yes	No	4 Gal.
FC7418-C	Yes	Yes	No	8 Gal.
FC7420-C	Yes	Yes	No	15 Gal.



E421 Solenoid
Use valve to control the flow of fluids not air



E230 Solenoid Valve
24V valve-Use for controlling the flow of air

P912 Solenoid Valve
110V valve-Use for controlling the flow of air

MX9330

PortaCart and Reservoir ONLY.
A portable cart to carry and transport a variety of LSP controller systems.

MX1330

PortaCart Only

MX1312

Heavy Duty Twelve Gallon Reservoir

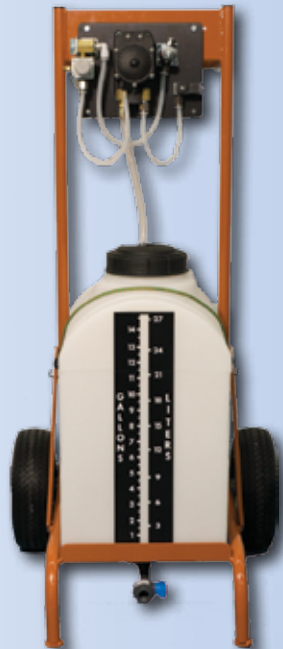

Proximity Sensor Cable
Extenders Allow Proximity Sensor to be moved an extended distance from the Controller
MX1350 10' Extender Cable
MX1351 15' Extender Cable



Manifold Cable Extenders
Allows Manifolds to be moved an extended distance from the Controller.
MX1301 6' Extender Cable
MX1303 15' Extender Cable
MX1305 60' Extender Cable

Low Level Controls

Can give a visual or sound signal if fluid is low. Can also be tied into the controls to shut the press down if lubricant is low.

E155 Four Gallon Reservoir
E158 Eight Gallon Reservoir
E165 Fifteen Gallon Reservoir



FC2125
On/Off Valve used to open and close the rolls



P.O. Box 5303, 61125 ♦ 5060 - 27TH AVE. ♦ ROCKFORD, IL 61109
TEL: 815-226-8090 ♦ FAX: 815-226-9250 ♦ E-MAIL: SALES@LSPIND.COM
WEB: WWW.LSPIND.COM